

# FW5071 User's Manual

## (Product Guide)

Version 4.12

September 30, 2011



### **Class A Digital Device (industrial & commercial environment)**

This equipment has been tested and found to comply with the limits for a Class A digital device, pursuant to CE and FCC Rules. These limits are designed to provide reasonable protection against harmful interference when the equipment is operated in a commercial environment. This equipment generates, uses and can radiate radio frequency energy and, if not installed and used in accordance with the instruction manual, may cause harmful interference to radio communications. Operation of this equipment in a residential area is likely to cause harmful interference in which case the user will be required to correct the interference at his own expense.

## **FW5071 User's Manual**

Document Part Number: M4047-01

Document Version: 4.12

Revised: September 30, 2011

### **About This Document**

This document is prepared for users of FW5071 supplied by Seyeon Tech Co., Ltd. It is assumed that the users are familiar with Microsoft Windows operating systems and Web browsers such as Internet Explorer. It is also assumed that the users are well aware of how to install and use the network equipment such as LAN, Hub, router, and having basic knowledge of network terminologies. If you have any questions regarding network installations, please contact your network equipment vendor or network administrator or Internet service providers.

For updated contents, detailed features and other applications from Seyeon Tech, please refer to the user's manual in CD-ROM provided with the product you purchased, or visit Seyeon Tech's Internet homepage at <http://www.flexwatch.com/>.

### **Copyright Notice**

Copyright © 2011 Seyeon Tech Co., Ltd. All rights reserved.

No part of this document may be reproduced in any form or by any means without the prior written permission of Seyeon Tech Co., Ltd.

### **Disclaimer**

Seyeon Tech Co., Ltd. (Seyeon Tech) Makes no representations or warranties with respect to the contents hereof. In addition, information contained herein is subject to change without notice. Every precaution has been taken in the preparation of this manual, nevertheless, Seyeon Tech assumes no responsibility for errors or omissions or any damages resulting from the use of the information contained in this document.

### **Trademarks**

FlexWATCH® and FlexWATCH® Logo are trademarks of Seyeon Tech Co., Ltd.

Windows and Internet Explorer are a trademark of Microsoft Corporation.

All other trademarks belong to their respective owners.

### **Technical Support**

For technical support call, email, or visit our web site.

Telephone: +82-2-2192-6800

Email: [sales@flexwatch.com](mailto:sales@flexwatch.com)

Web site: <http://www.flexwatch.com> or <http://www.seyeon.co.kr>

## Contents

<b>1. PRODUCT OVERVIEW .....</b>	<b>4</b>
1.1. FW5071 .....	4
1.2. KEY FEATURES .....	5
1.3. SPECIFICATION FOR FW5071 .....	6
1.4. FW5071 PACKING LIST .....	8
<b>2. HARDWARE DESCRIPTION .....</b>	<b>9</b>
2.1. FW5071 FRONT VIEW .....	9
2.2. FW5071 REAR VIEW .....	10
2.2.1. COM Port Description .....	11
<b>3. FW5071 INSTALLATION AND BASIC SETUP .....</b>	<b>12</b>
3.1. BEFORE INSTALLATION .....	12
3.2. FACTORY DEFAULT SETTINGS .....	12
3.3. INSTALLING FW5071 .....	12

## **1. Product Overview**

### **1.1. FW5071**

FlexWATCH® 5071 is a standalone, pure network video recorder which saves, transmits real-time video from FlexWATCH(Network Video Server, Network Camera) over TCP/IP network.

It can transmit up to 120fps@HD over the existing network. You can monitor video of FW5071 through web browser(ie. MS Internet Explorer), if FW5071 is connected to network. Saving & search is possible as well with HDD equipped.

FW5071 supports video compression Motion-JPEG, and H.264 simultaneously so that user can choose appropriate video compression for the purpose. A hard drive is equipped inside FW5071 so the video streams can be recorded and searched per user's need. The recording can be kept enabled all the time, or it can also be initiated by motion-detection, sensor input, or time scheduling. The searching feature provides various search conditions that can be combined together for efficiency.



**Picture 1 : FW5071**

### 1.2. Key Features

- Standalone device built-in web server
- 10M/100M/1000M Auto Sensing Ethernet
- Configuration and control device through Web browser
- Max 120 fps transmission speed on TCP/IP network
- Effective Bandwidth & Bit-rate Control (VBR/CBR) by H.264
- Support Dynamic IP network by IPCCTVDNS Server
- Support various PTZ (Pan/Tilt/Zoom) devices
- Provide Transparent mode
- Encryption function by user authentication
- Network server adding, saving
- Encryption on user authentication level
- User-friendly GUI for playback & export Video as AVI file
- Record Video by motion event

**1.3. Specification for FW5071**

Hardware	32bit Embedded CPU Flash 8Mbytes /SDRAM: DDR2 128Mbytes Linux version 2.6.24.4 operating system Battery backed up real-time clock
Video compression	Motion JPEG H.264
Recording	2 Step frame rate (Fast on event/Slow on continuous recording mode) Supports Linux File system Supports max 1.5 Tera SATA HDD Anti-shock system
Transmission or Recording (Single Mode)	Performance(1000Base-T / LAN) Trans : 120fps(NTSC)/100fps (PAL) Rec : 120fps(NTSC)/100fps (PAL) when Single Mode with total channels at HD
Transmission and Recording (Duplex Mode)	Performance(1000Base-T / LAN) Trans : 120fps(NTSC)/100fps (PAL) Rec : 110fps(NTSC)/100fps (PAL) when Duplex Mode with total channels at HD
Transmission and Recording and Playback (Triplex Mode)	Performance(1000Base-T / LAN) Trans : 120fps(NTSC)/100fps (PAL) Rec : 110fps(NTSC)/100fps (PAL) when Triplex Mode with total channels at HD
LAN interface	10/100/1000 BaseT Ethernet auto sensing
Serial Interface	One serial ports for console, modem(PSTN & GSM), serial input/output device, COM Port is RS-232, Max Baudrate: 115200 bit/s
Management	Configurable by serial, web or telnet Remote system update via telnet, FTP OR web browser.
Developer support	Provides HTTP CGI API ActiveX control development kit
PWR Consumption	DC 12Volt Max or Peak: 1.8 A Normal : 1.0 A (with Seagate Barracuda ES.2 1000Gbyte)
Operating Environment	Temperature : 32° ~ 122F (0° ~ 50°C) Humidity : 20 ~ 80% RH(non-condensing)
Miscellaneous	Freely downloadable NDVR Software Work with FW-Manager(NDVR S/W) Dynamic IP support through IPCCTVDNS Server
Users	Live-cast for up to 16x8 Channel Playback for up to 16 clients
Installation, management and maintenance	Installation CD and web-based configuration Firmware upgrades over HTTP or FTP, firmware available at <a href="http://www.flexwatch.com">www.flexwatch.com</a>



Video access from Web browser	Video access from Web browser
Minimum Web browsing requirements	Pentium 4, 2 GHz, 2GB(RAM) or higher Video Card: 256MB RAM, 1024x768 resolution or higher 100Mbps Network Adaptor or faster Windows XP Pro or later Internet Explorer 6.x or later
System integration support	Powerful API for software integration available at <a href="http://www.flexwatch.com">http://www.flexwatch.com</a> , including Simple Viewer API, FlexWATCH Control SDK, event trigger data in video stream, embedded scripting and access to serial port peripherals over HTTP/TCP User can be installed user program daemon for event notification or sending image. Embedded operating system: Linux 2.6
Supported protocols	HTTP, RTP/RTSP, TCP/IP, FTP, Telnet, RARP, PPPoE, PAP, CHAP, DHCP, SMTP client(e- mail), NTP
Applications (not included)	FlexWATCH Manager 16/32/128/256
Included Accessories	Power supply 12 V DC / Power cord CD (User's Manual, installation wizard and etc)
Not included Accessories	19" Rack Mount Bracket
Approvals	MIC FCC : Class A CE : Class A RoHS
Dimensions (HxWxD) and weight	224(L) x 140(W) x 44(H) (in mm) About 0.95kg without power supply & HDD.

*\* All specifications are subject to change without prior notice.*

**Table 1 : Specification for FW5071**

**1.4. FW5071 Packing List**

FW5071's packing box includes the following items

FW5071	1 EA	
(Power Cable & SMPS DC12V 5A Adapter)	1 EA	
HDD (option)	1 EA	
CD (User's Manual, installation wizard and Pictures)	1 EA	

**Table 2 : FW5071 Packing list**

 *Please check all the listed items are included in your package. For any missing items, please contact your local distributor.*



## 2. Hardware description

### 2.1. FW5071 Front View

Picture 2 : FW5071 Front panel

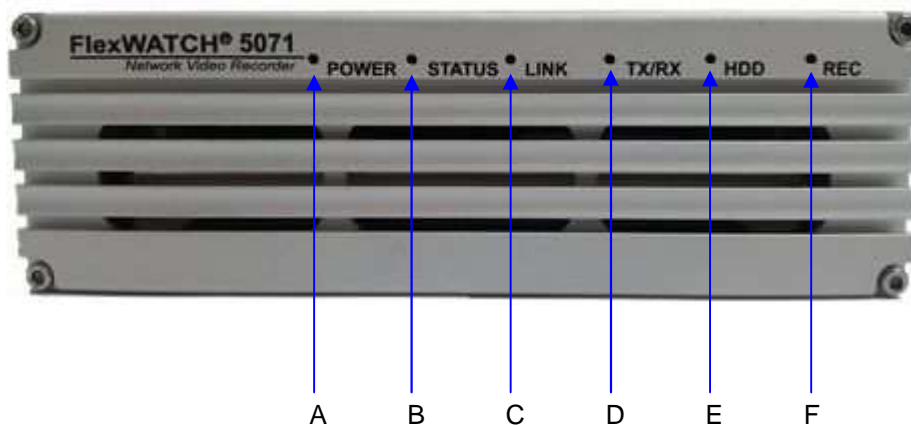

	PART	DESCRIPTION
A	POWER LED	Red LED is turned on with power provided.
B	STATUS LED	It indicates the status of operation & shutdown of FW5071. Yellow green LED turns on during normal operation after FW5071 boots.
C	LAN LINK LED	It indicates the status of access to LAN physically. Green LED turns on in case it accesses to LAN normally.
D	LAN(Tx/Rx) LED	Green light blinks when there is data transmission at the connected LAN.
E	HDD LED	Green light blinks when formatting or recording at HDD.
F	RECORDING LED	Red light blinks when HDD is recording.

Table 3 : FW5071 Front panel

#### Beep Sound Description



	Name	Description
1	Power ON	Beep one time shortly when power switch on.
2	System Ready	Beep two times when booting is finished.
3	Power Off	Beep two times (0.5 sec) when power switch off.
4	HDD Error	Beeps continuously for five seconds when HDD has an error. To make it keep quiet, you can set it on admin menu.
5	FD Button	Beep one time (0.5 sec) after three seconds and then beep three times shortly after another three seconds.

Table 4 : FW5071 Beep Sound

**2.2. FW5071 Rear View**

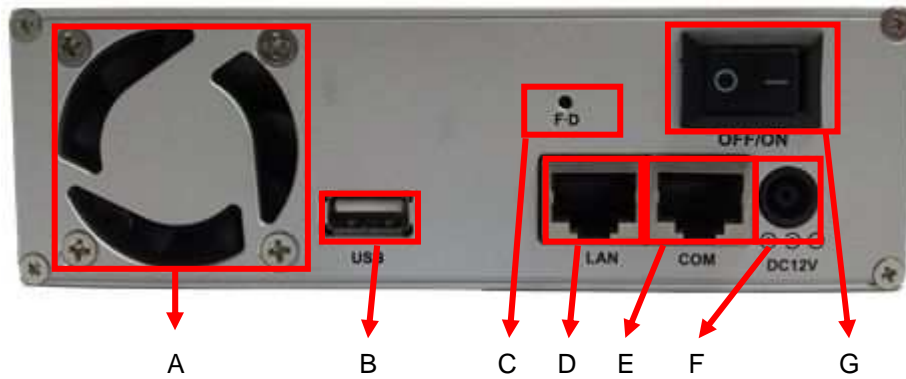
**Picture 3 : FW5071 Real panel**



	PART	DESCRIPTION
A	Cooling FAN	HDD Cooling FAN
B	USB	USB port (reserved for future use)
C	Factory Default Switch	It gets back system to factory default. Push the switch for 7 secs after system booting.
D	LAN	LAN port
E	COM	Needed to set up devices with Console ( UART-Out, UART-In)
F	Power	DC 12V 5A
		 <i>Do not push power switch right after power turns off.</i>
		 <i>Push power switch after HDD, FAN stops operation.</i>
G	Power Switch	Used to switch on/off power
		 <i>Do not turn off the power switch until format is completed since fatal problem happens if users turn off the switch during HDD format.</i>

**Table 5 : FW5071 Rear panel**

**2.2.1. COM Port Description**

Below image illustrates PIN No. of COM Port to connect in case of setting devices using console, numbers are displayed in order from the left.

For RS-232 connection, RXD& TXD& GND are used only in general, RXD and TXD should be crossed to communicate properly in case it connects with PC one by one.

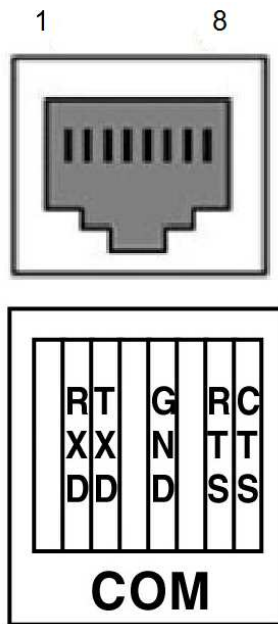

**Picture 4 : COM Port Description**

### 3. FW5071 Installation and Basic Setup

#### 3.1. Before Installation

- Read carefully User's Manual.
- Check User's Network (IP Address, Network Mask and default gateway)
- Secure IP address for FW5071.

#### 3.2. Factory Default Settings

The following table shows the factory default condition. Please refer to this when you need to change the values on admin menu.

	Factory Default
Admin ID	root
Admin password	root
IP address	10.20.30.40
Network mask	255.255.255.0
Gateway	10.20.30.1

**Table 5 : Factory Default**

*Note: Factory default Admin ID and Password are all lower case letters. You can change the password with Capital letters.*

#### 3.3. Installing FW5071

For installation of FW5071, please follow the steps below.

1. Place the FW5071 in place.
2. Connect the FW5071 to the Internet cable through the LAN port.
3. Connect the power supply of FW5071.

After that, you need to follow the steps below.

- Network Configuration: Refer to "IP Installer User's Manual"
- Camera Configuration: Refer to "FlexWATCH Admin Menu User's Manual"
- Service Configuration: Refer to "FlexWATCH Admin Menu User's Manual"